

### Description

- Industry standard SMD crystal  
Resistance welded, hermetically sealed in an inert atmosphere, glass to metal seals on leads  
Lead wires are mounted onto a plastic former to create a gull wing mount
- Model: HC49/4HSMX
- Model Issue number: 17

### Frequency Parameters

- Frequency: 20.0MHz
- Frequency Tolerance:  $\pm 30.00\text{ppm}$
- Tolerance Condition: @ 25°C  $\pm 2^\circ\text{C}$
- Frequency Stability:  $\pm 50.00\text{ppm}$
- Operating Temperature Range: -40.00 to 85.00°C
- Overtone Order: Fundamental
- Ageing:  $\pm 5\text{ppm typ per year @ } 25^\circ\text{C}$

### Electrical Parameters

- Load Capacitance (CL): 18.00pF
- Shunt Capacitance (C0): 7pF max
- Drive Level: 500µW max
- ESR: 40.00Ω max

### Environmental Parameters

- Shock: 981m/s<sup>2</sup>, 6ms, 3 times in each of 3 mutually perpendicular planes
- Vibration: 10Hz-60Hz, 0.75mm amplitude, 60Hz-500Hz, 98.1m/s<sup>2</sup>, 30mins in 3 mutually perpendicular planes
- Storage Temperature Range: -55 to 125°C

### Compliance

- RoHS Status (2011/65/EU): Compliant
- REACH Status: Compliant
- MSL Rating (JDEC-STD-033): Not Applicable

### Packaging Details

- Pack Style: Bulk Loose in bulk pack  
Pack Size: 100
- Alternative packing option available



### Outline (mm)

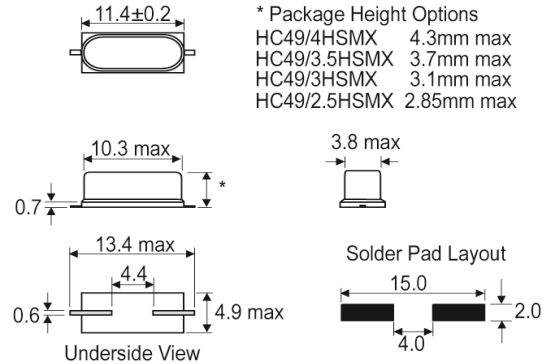

### Typical Frequency vs Temperature Curves

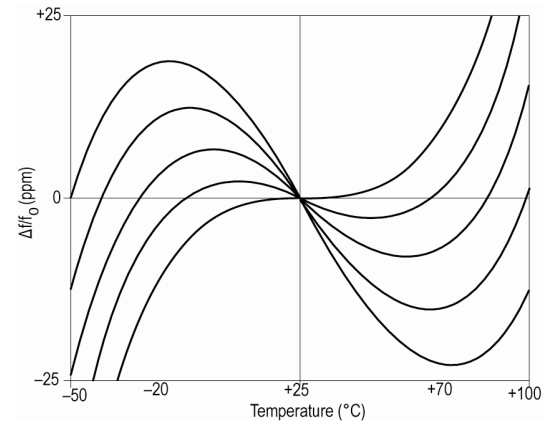

### Sales Office Contact Details:

UK: +44 (0)1460 270200  
Germany: 0800 1808 443

France: 0800 901 383  
USA: +1.760.318.2824

Email: [info@iqdfrequencyproducts.com](mailto:info@iqdfrequencyproducts.com)  
Web: [www.iqdfrequencyproducts.com](http://www.iqdfrequencyproducts.com)