

Basic Characteristics Data

Model	Circuit method	Switching frequency [kHz] (reference)	Input current [A]	Inrush current protection	PCB/Pattern			Series/Parallel operation availability	
					Material	Single sided	Double sided	Series operation	Parallel operation
SU/SUC1R5	Flyback converter	350 - 1900	Refer to Table1,2	-	glass fabric base,epoxy resin		Yes	Yes	* 1
SU/SUC3	Flyback converter	200 - 1400	Refer to Table1,2	-	glass fabric base,epoxy resin		Yes	Yes	* 1
SU/SUC6	Flyback converter	230 - 1950	Refer to Table1,2	-	glass fabric base,epoxy resin		Yes	Yes	* 1
SU/SUC10	Flyback converter	250 - 300	Refer to Table1,2	-	glass fabric base,epoxy resin		Yes	Yes	* 1
SUT3	Flyback converter	200 - 1400	Refer to Table1,2	-	glass fabric base,epoxy resin		Yes	Yes	* 1
SUT6	Flyback converter	230 - 1950	Refer to Table1,2	-	glass fabric base,epoxy resin		Yes	Yes	* 1
SUT10	Flyback converter	250 - 300	Refer to Table1,2	-	glass fabric base,epoxy resin		Yes	Yes	* 1

*1 Refer to Instruction Manual.

* The value of input current is measured at rated input and load.

Table1 (SUS*** +5V output)

[A]

Output Power	Input Voltage			
	5V	12V	24V	48V
1.5W	0.41	0.16	0.08	0.04
3W	0.78	0.32	0.16	0.08
6W	1.32	0.62	0.31	0.15
10W	2.41	0.98	0.49	0.25

Table2 (SUW*** ±12V output)

[A]

Output Power	Input Voltage			
	5V	12V	24V	48V
1.5W	0.43	0.17	0.09	0.04
3W	0.82	0.33	0.17	0.08
6W	1.54	0.59	0.29	0.15
10W	2.51	1.05	0.52	0.26

1	Pin Terminal Configuration	SU-SUC/SUT-48
2	Functions	SU-SUC/SUT-48
	2.1 Input Voltage Range	SU-SUC/SUT-48
	2.2 Overcurrent Protection	SU-SUC/SUT-48
	2.3 Isolation	SU-SUC/SUT-48
	2.4 Output Voltage Adjustment Range	SU-SUC/SUT-49
	2.5 Remote ON/OFF	SU-SUC/SUT-49
3	Wiring to Input/Output Pin Terminals	SU-SUC/SUT-50
4	Series/Parallel Operation	SU-SUC/SUT-51
	4.1 Series Operation	SU-SUC/SUT-51
	4.2 Redundancy Operation	SU-SUC/SUT-51
5	Input Voltage/Current Range	SU-SUC/SUT-51
6	Assembling and Installation	SU-SUC/SUT-51
	6.1 Installation	SU-SUC/SUT-51
	6.2 Automatic Mounting	SU-SUC/SUT-52
	6.3 Hand Mounting	SU-SUC/SUT-52
	6.4 Soldering Conditions	SU-SUC/SUT-52
	6.5 Stress to Pin Terminals	SU-SUC/SUT-52
	6.6 Cleaning	SU-SUC/SUT-53
7	Safety Standards	SU-SUC/SUT-53
8	Derating	SU-SUC/SUT-54
	8.1 SU/SUC1R5 Derating Curve	SU-SUC/SUT-54
	8.2 SU/SUC3 Derating Curve	SU-SUC/SUT-54
	8.3 SU/SUC6 Derating Curve	SU-SUC/SUT-55
	8.4 SU/SUC10 Derating Curve	SU-SUC/SUT-56
	8.5 SUT3 Derating Curve	SU-SUC/SUT-57
	8.6 SUT6 Derating Curve	SU-SUC/SUT-57
	8.7 SUT10 Derating Curve	SU-SUC/SUT-58
9	Peak Current (Pulse Load)	SU-SUC/SUT-59

10	Using DC-DC Converters	SU-SUC/SUT-59
11	Options	SU-SUC/SUT-60
	11.1 Outline of Options	SU-SUC/SUT-60
12	Delivery Package Information	SU-SUC/SUT-61

1 Pin Terminal Configuration

Table 1.1 Pin Terminal Configuration and Functions

Pin No.	Pin Terminal Name	Function
①	+Vin	+DC Input
②	RC	Remote ON/OFF (excluding 1R5)
③	-Vin	-DC Input
④	+Vout	+DC Output
⑤	COM	GND of Output Voltage (for Dual Output)
⑥	TRM	Output Voltage Adjustment (please see 2.4)
⑦	-Vout	-DC Output
⑧	Case Connecting Pin	If connected to -Vin, a case potential becomes fixed and radiation noise decreases (applicable only to SUC series).

●Single Output

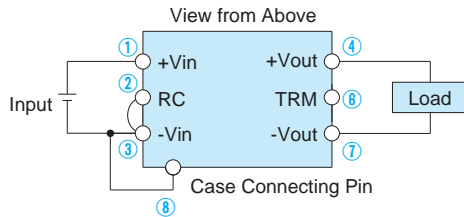

●Dual(±)Output

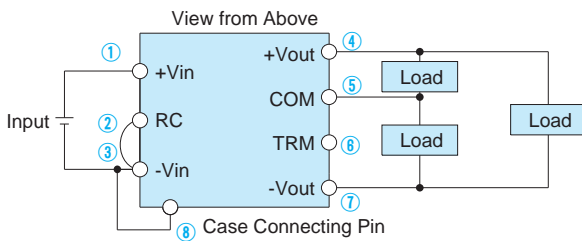

Fig.1.1 Pin Configuration

Table 1.2 Pin Terminal Configuration and Functions

Pin No.	Pin Terminal Name	Function
①	-Vin	-DC Input
②	RC	Remote ON/OFF
③	+Vin	+DC Input
④	+Vout	+DC Output
⑤	NC (Single output) COM (Dual output)	—————
⑥	TRM	Output Voltage Adjustment
⑦	-Vout	-DC Output
⑧	Case Connecting Pin	If connected to -Vin, a case potential becomes fixed and radiation noise decreases.

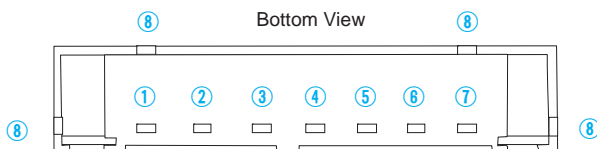

Fig.1.2 Pin Terminal Configuration

●Case Connecting Pin Terminal

Units come with a case connecting pin terminal. If this pin terminal is connected to -Vin, radiation noise from the main body decreases. Solder the case connecting pin terminal to PCB to improve reliability.

2 Functions

2.1 Input Voltage Range

■ If output voltage value doesn't fall within specifications, a unit may not operate in accordance with specifications and/or fail.

2.2 Overcurrent Protection

■ Overcurrent Operation

An overcurrent protection circuit is built-in and activated at 105% of the rated current or above. It prevents the unit from short circuit and overcurrent for less than 20 seconds. The unit automatically recovers when the fault condition is removed.

■ Current Foldback Characteristic

If a model that has a current foldback characteristic is connected to a non-linear load such as lamp or motor, or to a constant current load, it may not start up. Please see the characteristics below.

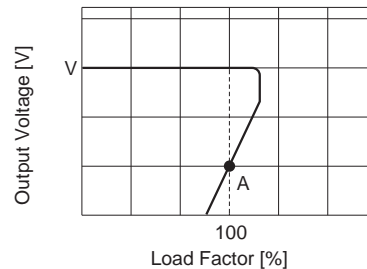

————— : Load Characteristic of Power Supply

----- : Characteristic of Load (Lamp, Motor or Constant Current Load, etc.)

Note : The output may be locked out at Point A when the unit is connected to a lamp, motor or constant current load.

Fig.2.1 Current Foldback Characteristic

2.3 Isolation

■ When you run a Hi-Pot test as receiving inspection, gradually increase the voltage to start. When you shut down, decrease the voltage gradually by using a dial. Please avoid a Hi-Pot tester with a timer because, when the timer is turned ON or OFF, it may generate a voltage a few times higher than the applied voltage.

2.4 Output Voltage Adjustment Range

- The output voltage is adjustable through an external potentiometer. Adjust only within the range of $\pm 5\%$ of the rated voltage.
- To increase the output voltage, turn the potentiometer clockwise and connect in such a way that the resistance value between ② and ③ becomes small.
- To decrease the output voltage, turn the potentiometer counter-clockwise.
- Please use a wire as short as possible to connect to the potentiometer and connect it from the pin terminal on the power supply side. Temperature coefficient deteriorates when some types of resistors and potentiometers are used. Please use the following types.
Resistor.....Metal Film Type, Temperature Coefficient of $\pm 100\text{ppm}/^\circ\text{C}$ or below
Potentiometer...Cermet Type, Temperature Coefficient of $\pm 300\text{ppm}/^\circ\text{C}$ or below
- If output voltage adjustment is not required, open the pin terminal TRM.
- In the case of dual output, \pm voltages are adjusted simultaneously.

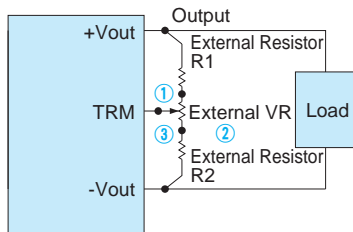

Fig.2.2 Connecting External Devices

Table 2.1 List of External Devices

Item #	Output Voltage	Constant of External Device [Ω] (Adjustable within $\pm 5\%$)		
		VR	R1	R2
1	3.3V	1K	100	100
2	5V	1K	100	270
3	12V	5K	10K	1.2K
4	15V	5K	10K	470
5	$\pm 12\text{V}$	5K	18K	470
6	$\pm 15\text{V}$	5K	18K	470

2.5 Remote ON/OFF (Excluding 1R5)

- You can turn the power supply ON or OFF without turning the input power ON or OFF through the pin terminal RC.

(1) SU/SUC3/SUT3 and SU/SUC6/SUT6

- The output of the power supply turns ON when the pin terminal RC is connected to the pin terminal -Vin. When the voltage of the pin terminal RC is between 2.0 to 9.0V, the output of the power supply goes OFF.
- When the voltage of the pin terminal RC is between 0.3 to 2.0V, the output voltage value may be an uncertain value which is less than the rated voltage.
- Please see the following diagram for how to use the pin terminal RC.

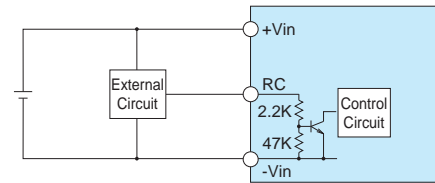

Fig.2.3 Internal Circuits of Remote ON/OFF

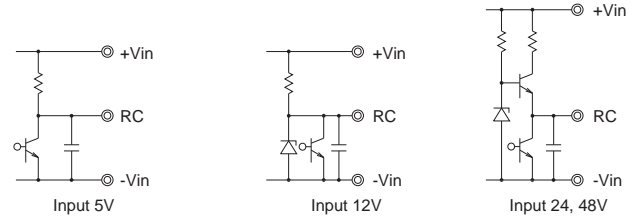

Fig.2.4 Examples of Using an External Remote ON/OFF Circuit

Table 2.2 Specification of Remote ON/OFF

Voltage Level of the pin terminal RC (V_{RC})	SU/SUC3/SUT3, SU/SUC6/SUT6 Output
Open or Short or $0\text{V} \leq V_{RC} \leq 0.3\text{V}$	ON
$2.0\text{V} \leq V_{RC} \leq 9.0\text{V}$	OFF

- Please keep the voltage level of the pin terminal RC (V_{RC}) at 9.0V or below.
- If you do not use the Remote ON/OFF function, please short out between the pin terminals RC and -Vin to prevent malfunction.

(2) SU/SUC10/SUT10

- The output of the power supply turns ON when the pin terminal RC is connected to the pin terminal -Vin. When the pin terminal RC is open or the voltage of the pin terminal RC is between 2.4 to 7.0 V, the output of the power supply goes OFF.
- When the voltage of the pin terminal RC is between 1.2 to 2.4V, an output voltage value may be an uncertain value which is less than the rated voltage.
- Please see the following diagram for how to use the pin terminal RC.

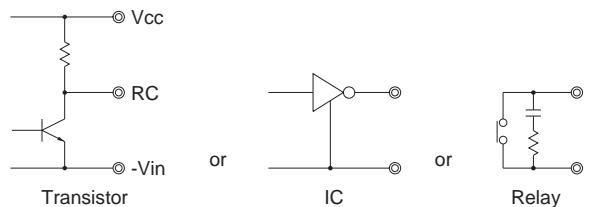

Fig.2.5 Examples of Using an External Remote ON/OFF Circuit

Table 2.3 Specification of Remote ON/OFF

Voltage Level of the pin terminal RC (V_{RC})	SU/SUC10/SUT10 Output
Short or $0\text{V} \leq V_{RC} \leq 1.2\text{V}$	ON
Open or $2.4\text{V} \leq V_{RC} \leq 7.0\text{V}$	OFF

- When the pin terminal RC is at the "Low" level, outflowing current is 0.5mA typ. When Vcc is used, please make sure that the voltage of Vcc is 7.0V or less.
- If you do not use the Remote ON/OFF function, please short out between the pin terminals RC and -Vin.

3 Wiring to Input/Output Pin Terminals

- Basically, SU/SUC/SUT series do not need any external capacitor. However, you can create a π -shaped filter circuit by adding a capacitor C_i near the input pin terminal and reduce reflected input noise from a converter. Please connect the capacitor as needed.
- When you use a capacitor C_i , please use the one with high frequency and good temperature characteristics.
- If the power module is to be turned ON/OFF directly with a switch, inductance from the input line will induce a surge voltage several times that of the input voltage and it may damage the power module. Make sure that the surge is absorbed, for example, by connecting an electrolytic capacitor between the input pins.
- If an external filter containing L (inductance) is added to the input line or a wire from the input source to the DC-DC converter is long, not only the reflected input noise becomes large, but also the output of the converter may become unstable. In such case, connecting C_i to the input pin terminal is recommended.
- If you use an aluminum electrolytic capacitor, please pay attention to its ripple current rating.

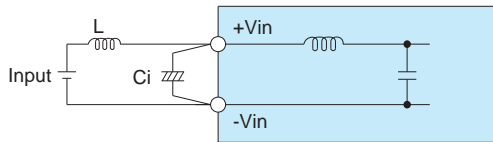

Fig.3.1 Connecting an External Capacitor to the Input Side

Table 3.1 Recommended Capacitance of an External Capacitor on the Input Side [μF]

Model Input Voltage(V)	SU/SUC1R5	SU/SUC3/SUT3	SU/SUC6/SUT6	SU/SUC10/SUT10
5	10 - 100	10 - 220	10 - 470	10 - 470
12	10 - 47	10 - 100	10 - 220	10 - 220
24	10 - 33	10 - 47	10 - 100	10 - 100
48	4.7 - 10	10 - 22	10 - 47	10 - 47

* Please adjust the capacitance in accordance with a degree of the effect you want to achieve.

- If a reverse polarity voltage is applied to the input pin terminal, the power supply will fail.

If there is a possibility that a reverse polarity voltage is applied, connect a protection circuit externally as described below.

(a)

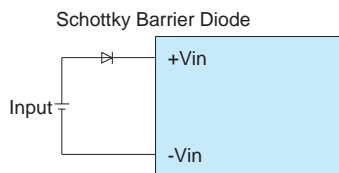

Schottky barrier diode generates a power loss of input current multiplied by forward voltage.

(b)

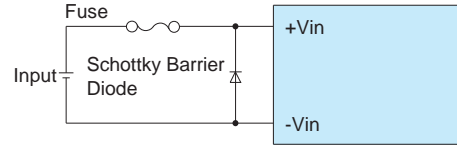

Fig.3.2 Connecting a Reverse Voltage Protection Circuit

- Basically, SU/SUC/SUT series do not need any external capacitor. However, if you want to further reduce the output ripple noise, connect an electrolytic capacitor or a ceramic capacitor C_o to the output pin terminal as shown below.

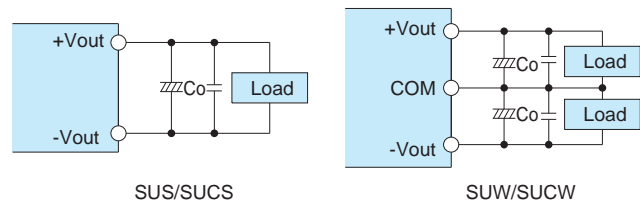

Fig.3.3 Connecting Example of an External Capacitor to the Output Side

Table 3.2 Recommended Capacitance of External Capacitor on the Output Side [μF]

Model Output Voltage(V)	SU/SUC1R5	SU/SUC3/SUT3	SU/SUC6/SUT6	SU/SUC10/SUT10
3.3	1 - 100	1 - 220	1 - 220	1 - 220
5	1 - 100	1 - 220	1 - 220	1 - 220
12	1 - 100	1 - 100	1 - 100	1 - 100
15	1 - 100	1 - 100	1 - 100	1 - 100

* If you use a ceramic capacitor, keep the capacitance within the range between about 0.1 to 10 μF .

* Please adjust the capacitance in light of the effect you want to achieve.

* If you need to use an external capacitor whose capacitance exceeds the range provided in Table 3.2, please contact us.

- If the distance between the output and the load is long and therefore the noise is created on the load side, connect a capacitor externally to the load as shown below.

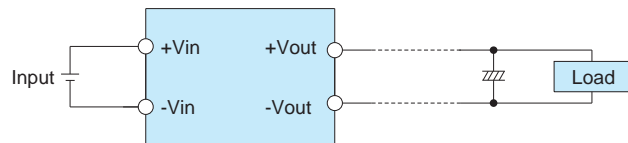

4 Series/Parallel Operation

4.1 Series Operation

■ You can use the power supplies in series operation by wiring as shown below. In the case of (a) below, the output current should be lower than the rated current of a power supply with the lowest rated current among power supplies that are serially connected. Please make sure that no current exceeding the rated current flows into a power supply.

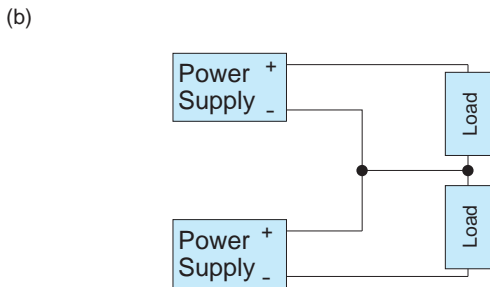
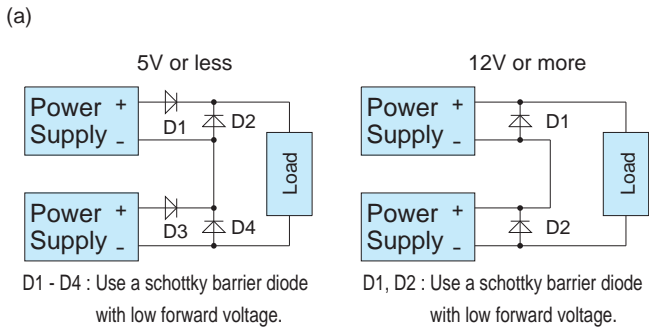

Fig.4.1 Series Operation

4.2 Redundancy Operation

■ You can use the power supplies in redundancy operation by wiring as shown below.

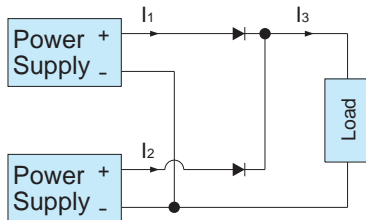

Fig.4.2 Redundancy Operation

■ Even a slight difference in output voltage can affect the balance between the values of I_1 and I_2 . Please make sure that the value of I_3 does not exceed the rated current of a power supply.

$$I_3 \leq \text{Rated Current Value}$$

5 Input Voltage/Current Range

■ If you use a non-regulated power source for input, please check and make sure that its voltage fluctuation range and ripple voltage do not exceed the input voltage range shown in specifications.

■ Please select an input power source with enough capacity, taking into consideration of the start-up current (I_p), which flows when a DC-DC converter starts up.

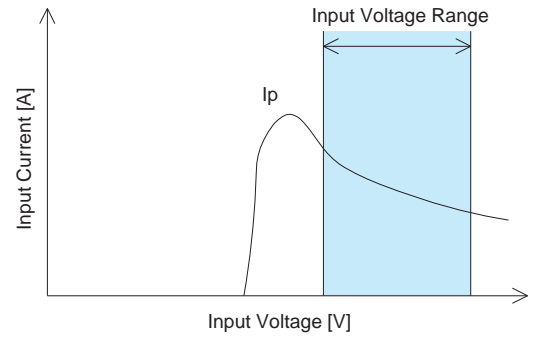

Fig.5.1 Input Current Characteristics

6 Assembling and Installation

6.1 Installation

■ You can install the units in any direction. Place them in such a way that there is enough ventilation so that heat does not get accumulated around them.

■ Do not place a rand or a pattern layout in the hatched area shown in Fig. 6.1, 6.2. Doing so may cause insulation failure on the PCB surface on which the power supply is mounted.

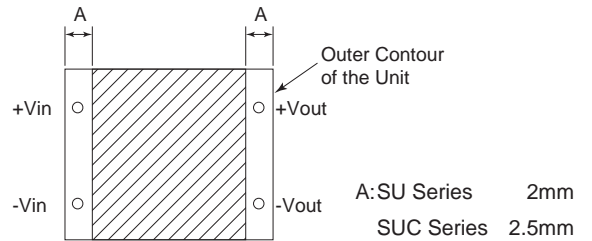

Fig.6.1 Area where Pattern Layout should not be Placed for SU/SUC

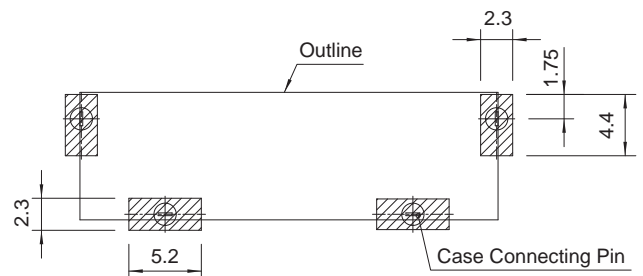

Fig.6.2 Area where Pattern Layout should not be Placed for SUT

6.2 Automatic Mounting (TYPE: BP)

■To mount SU series automatically, use the transformer area near the center of the PCB as a pickup point. To mount SUC series automatically, use the central area of the case as a pickup point. If the bottom dead point of a suction nozzle is too low when mounting, excessive force is applied to the transformer, which could cause damage. Please mount carefully.
Please see the External View for details of the pickup point.

6.3 Hand Mounting (TYPE:B,C SUT)

■To mount SU series manually, it must be push the transformer placed center of PS.
■To mount SUC series manually, it must be push the center of case.
■Due to prevent failure, PS should not be pull after soldering with PCB.

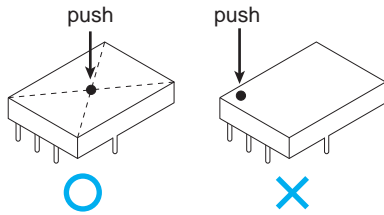

Fig.6.3 Hand mounting

6.4 Soldering Conditions

(1) Reflow Soldering (except SUT, SUC□□C-C)

- Fig.6.4 shows conditions for the reflow soldering for SU/SUC series. Please make sure that the temperatures of pin terminals +Vin and -Vout shown in Fig.6.4 do not exceed the temperatures shown in Fig.6.5.
- If time or temperature of the reflow soldering goes beyond the conditions, reliability of internal components may be compromised. Please use the unit under the recommended reflow conditions.
- With this reflow profile, internal solder melts down. When transporting the unit within the reflow oven, please do not give vibration to the unit.
- Please avoid reflow soldering after applying adhesive or coating to the unit.
- You can reflow solder up to 2 times. Do not reflow solder when the power supply is mounted on the back surface of the PCB because the unit may drop.



Fig.6.4 Temperature Measuring Points when Setting Reflow Soldering Conditions (View from Above)

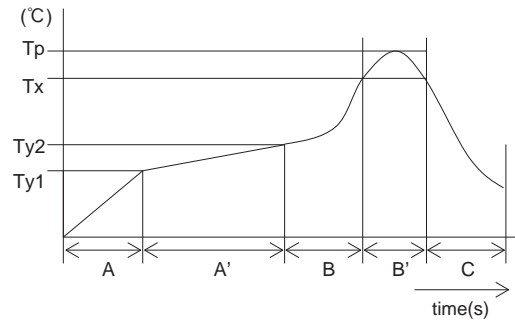

A	1.0 - 5.0°C/s
A'	Ty1 : 160 ±20°C
	Ty2 : 180 ±20°C
B	1.0 - 5.0°C/s
B'	Tp : Max 245°C 10s max
	Tx : 220°C or more : 70s max
C	1.0 - 5.0°C/s

Fig.6.5 Recommend Reflow Soldering Conditions

- (2) Flow Soldering : 260°C 15 seconds or less
- (3) Soldering Iron : maximum 360°C 5 seconds or less

6.5 Stress to Pin Terminals

- If too much stress is applied to input/output pin terminals of the power supply, internal connection may come down. If you apply stress as shown below, please kept it at 19.6N (2kgf) or less vertically.
- Input/output pin terminals are soldered to the PCB internally. Do not pull or bend a lead powerfully.
- If it is expected that stress is applied to the input/output pin terminals due to vibration or impact, reduce the stress to the pin terminals by taking such measures as fixing the unit to the PCB by silicone rubber, etc.

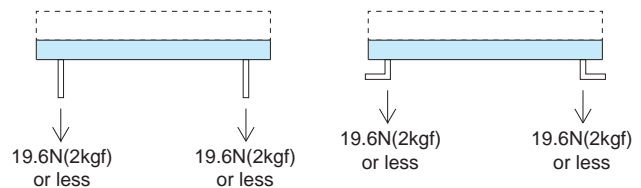

Fig.6.6 Strength of Input/Output Pin Terminals for SU/SUC

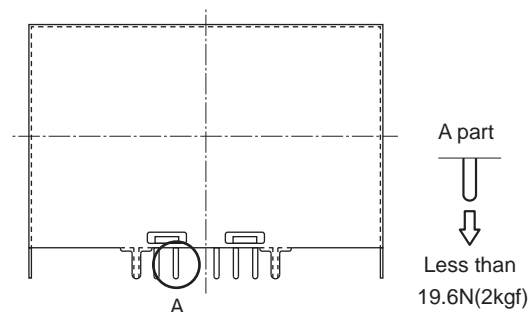

Fig.6.7 Strength of Input/Output Pin Terminals for SUT

6.6 Cleaning (except SUC□□C-C)

■If you need to clean the unit, please clean it under the following conditions.

Cleaning Method: Varnishing, Ultrasonic or Vapor Cleaning

Cleaning agent: IPA (Solvent type)

Cleaning Time: Within total 2 minutes for varnishing, ultrasonic and vapor cleaning

■Please dry the unit sufficiently after cleaning.

■If you do ultrasonic cleaning, please keep the ultrasonic output at 15W/ℓ or below.

7 Safety Standards

■To apply for a safety standard approval using the power supply, please meet the following conditions. Please contact us for details.

●Please use the unit as a component of an end device.

●The area between the input and the output of the unit is isolated functionally. Depending upon the input voltage, basic insulation, dual insulation or enhanced insulation may be needed. In such case, please take care of it within the structure of your end-device. Please contact us for details.

■Please use the following model names when you apply for a safety standard approval.

●SU/SUC1R5

SUS1R5053R3	SUS1R5123R3	SUS1R5243R3	SUS1R5483R3
SUS1R50505	SUS1R51205	SUS1R52405	SUS1R54805
SUS1R50512	SUS1R51212	SUS1R52412	SUS1R54812
SUS1R50515	SUS1R51215	SUS1R52415	SUS1R54815
SUW1R50512	SUW1R51212	SUW1R52412	SUW1R54812
SUW1R50515	SUW1R51215	SUW1R52415	SUW1R54815

SUCS1R5053R3	SUCS1R5123R3	SUCS1R5243R3	SUCS1R5483R3
SUCS1R50505	SUCS1R51205	SUCS1R52405	SUCS1R54805
SUCS1R50512	SUCS1R51212	SUCS1R52412	SUCS1R54812
SUCS1R50515	SUCS1R51215	SUCS1R52415	SUCS1R54815
SUCW1R50512	SUCW1R51212	SUCW1R52412	SUCW1R54812
SUCW1R50515	SUCW1R51215	SUCW1R52415	SUCW1R54815

●SU/SUC3

SUS3053R3	SUS3123R3	SUS3243R3	SUS3483R3
SUS30505	SUS31205	SUS32405	SUS34805
SUS30512	SUS31212	SUS32412	SUS34812
SUS30515	SUS31215	SUS32415	SUS34815
SUW30512	SUW31212	SUW32412	SUW34812
SUW30515	SUW31215	SUW32415	SUW34815

SUCS3053R3	SUCS3123R3	SUCS3243R3	SUCS3483R3
SUCS30505	SUCS31205	SUCS32405	SUCS34805
SUCS30512	SUCS31212	SUCS32412	SUCS34812
SUCS30515	SUCS31215	SUCS32415	SUCS34815
SUCW30512	SUCW31212	SUCW32412	SUCW34812
SUCW30515	SUCW31215	SUCW32415	SUCW34815

●SU/SUC6

SUS6053R3	SUS6123R3	SUS6243R3	SUS6483R3
SUS60505	SUS61205	SUS62405	SUS64805
SUS60512	SUS61212	SUS62412	SUS64812
SUS60515	SUS61215	SUS62415	SUS64815
SUW60512	SUW61212	SUW62412	SUW64812
SUW60515	SUW61215	SUW62415	SUW64815

SUCS6053R3	SUCS6123R3	SUCS6243R3	SUCS6483R3
SUCS60505	SUCS61205	SUCS62405	SUCS64805
SUCS60512	SUCS61212	SUCS62412	SUCS64812
SUCS60515	SUCS61215	SUCS62415	SUCS64815
SUCW60512	SUCW61212	SUCW62412	SUCW64812
SUCW60515	SUCW61215	SUCW62415	SUCW64815

●SU/SUC10

SUS10053R3	SUS10123R3	SUS10243R3	SUS10483R3
SUS100505	SUS101205	SUS102405	SUS104805
SUS100512	SUS101212	SUS102412	SUS104812
SUS100515	SUS101215	SUS102415	SUS104815
SUW100512	SUW101212	SUW102412	SUW104812
SUW100515	SUW101215	SUW102415	SUW104815

SUCS10053R3	SUCS10123R3	SUCS10243R3	SUCS10483R3
SUCS100505	SUCS101205	SUCS102405	SUCS104805
SUCS100512	SUCS101212	SUCS102412	SUCS104812
SUCS100515	SUCS101215	SUCS102415	SUCS104815
SUCW100512	SUCW101212	SUCW102412	SUCW104812
SUCW100515	SUCW101215	SUCW102415	SUCW104815

●SUT3

SUTS3053R3	SUTS3123R3	SUTS3243R3	SUTS3483R3
SUTS30505	SUTS31205	SUTS32405	SUTS34805
SUTS30512	SUTS31212	SUTS32412	SUTS34812
SUTS30515	SUTS31215	SUTS32415	SUTS34815
SUTW30512	SUTW31212	SUTW32412	SUTW34812
SUTW30515	SUTW31215	SUTW32415	SUTW34815

●SUT6

SUTS6053R3	SUTS6123R3	SUTS6243R3	SUTS6483R3
SUTS60505	SUTS61205	SUTS62405	SUTS64805
SUTS60512	SUTS61212	SUTS62412	SUTS64812
SUTS60515	SUTS61215	SUTS62415	SUTS64815
SUTW60512	SUTW61212	SUTW62412	SUTW64812
SUTW60515	SUTW61215	SUTW62415	SUTW64815

●SUT10

SUTS10053R3	SUTS10123R3	SUTS10243R3	SUTS10483R3
SUTS100505	SUTS101205	SUTS102405	SUTS104805
SUTS100512	SUTS101212	SUTS102412	SUTS104812
SUTS100515	SUTS101215	SUTS102415	SUTS104815
SUTW100512	SUTW101212	SUTW102412	SUTW104812
SUTW100515	SUTW101215	SUTW102415	SUTW104815

8 Derating

It is necessary to note thermal fatigue life by power cycle. Please reduce the temperature fluctuation range as much as possible when the up and down of temperature are frequently generated.

8.1 SU/SUC1R5 Derating Curve

If you derate the output current, you can use the unit in the temperature range from -40°C to the maximum temperature shown below.

(1) In the case of Convection Cooling

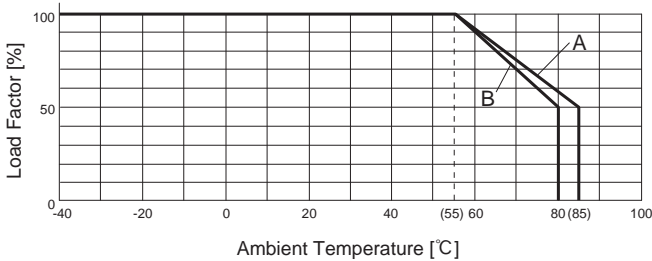

Output Voltage(V) Input Voltage(V)	3.3	5	12	15	±12	±15
5	A	A	A	A	A	A
12	A	A	A	A	A	A
24	A	A	A	A	A	A
48	B	B	B	B	B	B

Fig.8.1 Derating Curve for Convection Cooling (SU/SUC1R5)

(2) In the case of Forced Air Cooling (1m/s)

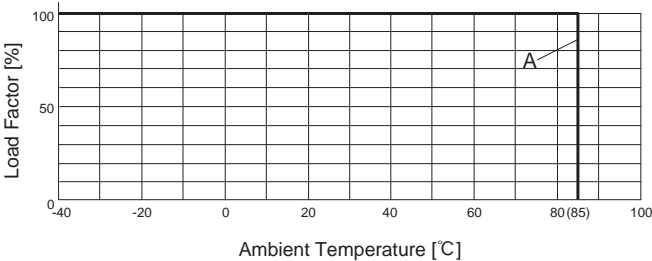

Output Voltage(V) Input Voltage(V)	3.3	5	12	15	±12	±15
5	A	A	A	A	A	A
12	A	A	A	A	A	A
24	A	A	A	A	A	A
48	A	A	A	A	A	A

Fig.8.2 Derating Curve for Forced Air Cooling (1m/s) (SU/SUC1R5)

(3) Temperature Measuring Points in the case of Forced Air Cooling (1m/s)

① SU1R5

In the case of forced air cooling, please have sufficient ventilation to keep the temperature of point A in Fig.8.3 at 105°C or below. Please also make sure that the ambient temperature does not exceed 85°C.

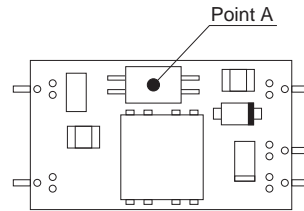

Fig.8.3 Temperature Measuring Point in the case of Forced Air Cooling

② SUC1R5

In the case of forced air cooling, please have sufficient ventilation to keep the temperature of point B in Fig.8.4 at 95°C or below. Please also make sure that the ambient temperature does not exceed 85°C.

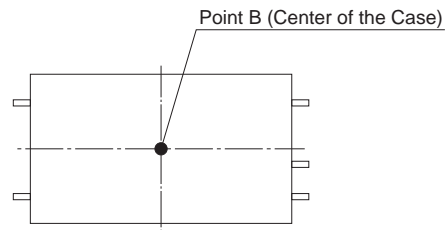
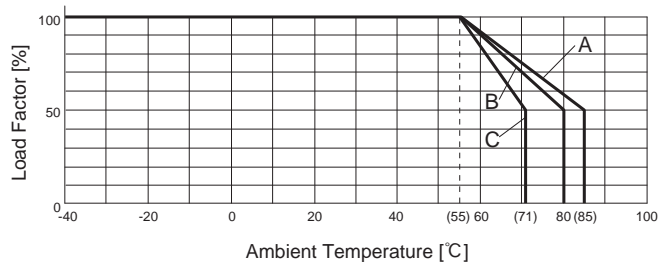

Fig.8.4 Temperature Measuring Point in the case of Forced Air Cooling (Upper Surface of the Case)

8.2 SU/SUC3 Derating Curve

If you derate the output current, you can use the unit in the temperature range from -40°C to the maximum temperature shown below.

(1) In the case of Convection Cooling



Output Voltage(V) Input Voltage(V)	3.3	5	12	15	±12	±15
5	A	A	B	B	A	B
12	A	A	B	B	A	B
24	A	A	B	B	A	B
48	B	B	B	B	A	C

Fig.8.5 Derating Curve for Convection Cooling (SU/SUC3)

(2) In the case of Forced Air Cooling (1m/s)

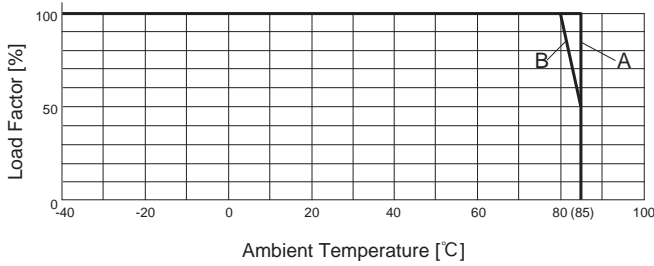

Output Voltage(V) Input Voltage(V)	3.3	5	12	15	±12	±15
5	A	B	B	B	B	B
12	A	A	A	A	A	B
24	A	A	B	A	A	B
48	A	A	A	A	A	B

Fig.8.6 Derating Curve for Forced Air Cooling (1m/s) (SU/SUC3)

(3) Temperature Measuring Points in the case of Forced Air Cooling (1m/s)

① SU3

■ In the case of forced air cooling, please have sufficient ventilation to keep the temperature of point A in Fig.8.7 at 115°C or below and that of Point B at 120°C or below. Please also make sure that the ambient temperature does not exceed 85°C.

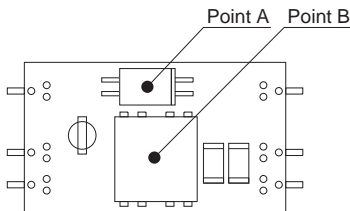

Fig.8.7 Temperature Measuring Points in the case of Forced Air Cooling

② SUC3

■ In the case of forced air cooling, please have sufficient ventilation to keep the temperature of point C in Fig.8.8 at 100°C or below. Please also make sure that the ambient temperature does not exceed 85°C.

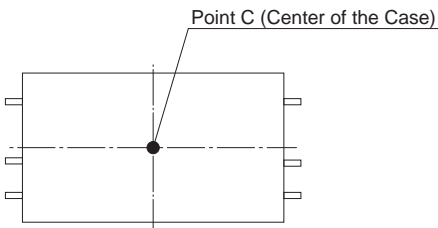
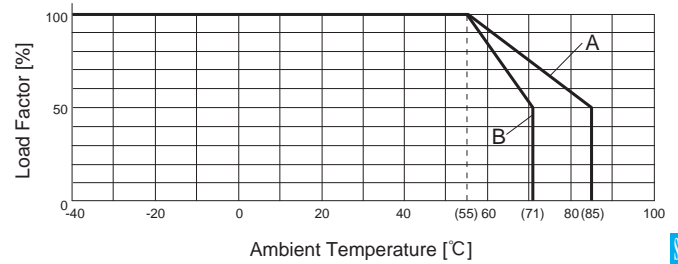

Fig.8.8 Temperature Measuring Point in the case of Forced Air Cooling (Upper Surface of the Case)

8.3 SU/SUC6 Derating Curve

■ If you derate the output current, you can use the unit in the temperature range from -40°C to the maximum temperature shown below.

(1) In the case of Convection Cooling



Output Voltage(V) Input Voltage(V)	3.3	5	12	15	±12	±15
5	B	B	B	B	B	B
12	B	B	B	B	B	B
24	B	B	B	B	B	B
48	B	B	A	A	A	A

Fig.8.9 Derating Curve for Convection Cooling (SU/SUC6)

(2) In the case of Forced Air Cooling (1m/s)

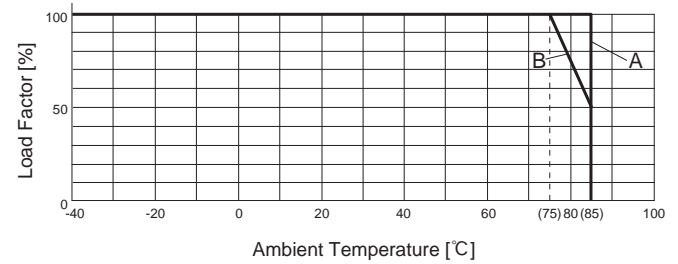

Output Voltage(V) Input Voltage(V)	3.3	5	12	15	±12	±15
5	B	B	A	A	A	A
12	B	B	A	A	A	A
24	B	B	A	A	A	A
48	B	B	A	A	A	A

Fig.8.10 Derating Curve for Forced Air Cooling (1m/s) (SU/SUC6)

(3) Temperature Measuring Points in the case of Forced Air Cooling (1m/s)

① SU6

■ In the case of forced air cooling, please have sufficient ventilation to keep the temperature of point A in Fig.8.11 at 95°C or below and that of Point B at 115°C or below. Please also make sure that the ambient temperature does not exceed 85°C.

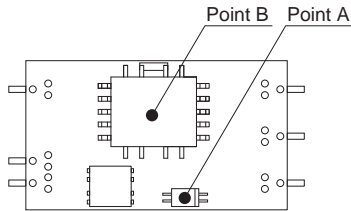

Fig.8.11 Temperature Measuring Points in the case of Forced Air Cooling

② SUC6

■ In the case of forced air cooling, please have sufficient ventilation to keep the temperature of point C in Fig.8.12 at 95°C or below. Please also make sure that the ambient temperature does not exceed 85°C.

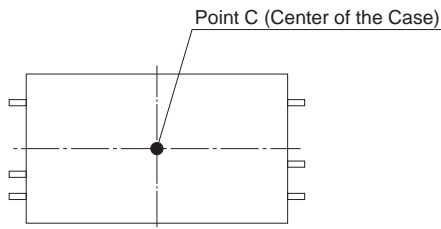
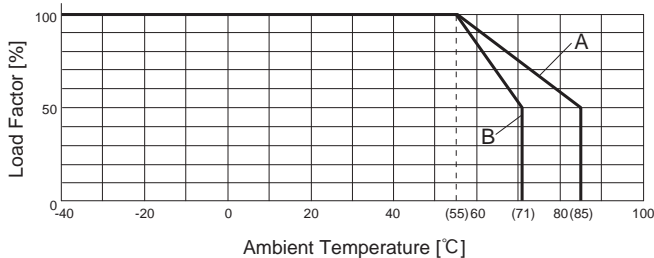

Fig.8.12 Temperature Measuring Point in the case of Forced Air Cooling (Upper Surface of the Case)

8.4 SU/SUC10 Derating Curve

■ If you derate the output current, you can use the unit in the temperature range from -40°C to the maximum temperature shown below.

(1) In the case of Convection Cooling



Output Voltage(V) Input Voltage(V)	3.3	5	12	15	±12	±15
5	B	A	A	A	A	A
12	B	A	A	A	A	A
24	B	A	A	A	A	A
48	B	B	B	B	B	B

Fig.8.13 Derating Curve for Convection Cooling (SU/SUC10)

(2) In the case of Forced Air Cooling (1m/s)

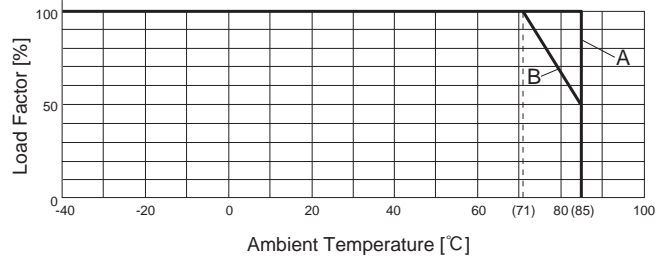

Output Voltage(V) Input Voltage(V)	3.3	5	12	15	±12	±15
5	B	B	B	B	A	A
12	B	B	B	B	A	A
24	B	B	B	B	A	A
48	B	B	B	B	B	B

Fig.8.14 Derating Curve for Forced Air Cooling (1m/s) (SU/SUC10)

(3) Temperature Measuring Points in the case of Forced Air Cooling (1m/s)

① SU10

■ In the case of forced air cooling, please have sufficient ventilation to keep the temperature of point A in Fig.8.15 at 105°C or below. Please also make sure that the ambient temperature does not exceed 85°C.

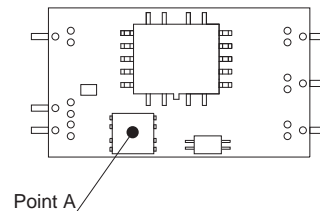

Fig.8.15 Temperature Measuring Point in the case of Forced Air Cooling

② SUC10

■ In the case of forced air cooling, please have sufficient ventilation to keep the temperature of point B in Fig.8.16 at 95°C or below. Please also make sure that the ambient temperature does not exceed 85°C.

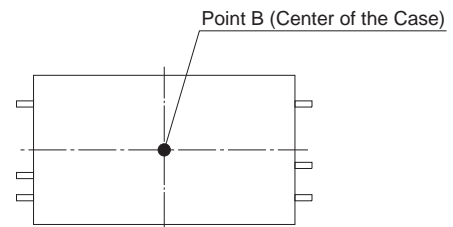
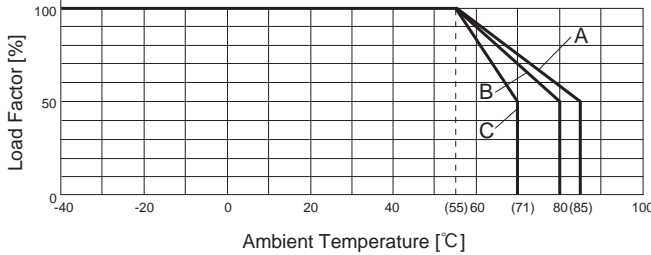

Fig.8.16 Temperature Measuring Point in the case of Forced Air Cooling (Upper Surface of the Case)

8.5 SUT3 Derating Curve

■ If you derate the output current, you can use the unit in the temperature range from -40°C to the maximum temperature shown below.

(1) In the case of Convection Cooling



Output Voltage(V) Input Voltage(V)	3.3	5	12	15	±12	±15
5	A	A	B	B	A	B
12	A	A	B	B	A	B
24	A	A	B	B	A	B
48	B	B	B	B	A	C

Fig.8.17 Derating Curve for Convection Cooling (SUT3)

(2) In the case of Forced Air Cooling (1m/s)

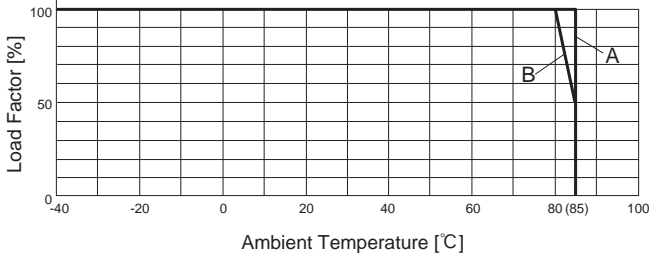

Output Voltage(V) Input Voltage(V)	3.3	5	12	15	±12	±15
5	A	B	B	B	B	B
12	A	A	A	A	A	B
24	A	A	B	A	A	B
48	A	A	A	A	A	B

Fig.8.18 Derating Curve for Forced Air Cooling (1m/s) (SUT3)

(3) Temperature Measuring Points in the case of Forced Air Cooling (1m/s)

■ In the case of forced air cooling, please have sufficient ventilation to keep the temperature of point A in Fig.8.19 at 100°C or below. Please also make sure that the ambient temperature does not exceed 85°C.

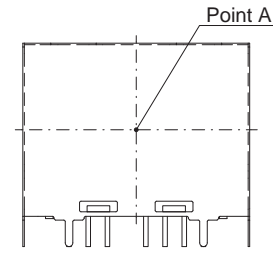
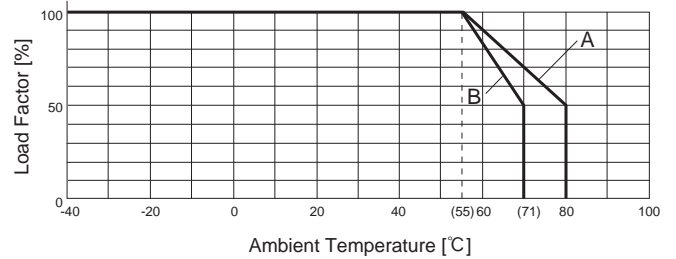

Fig.8.19 Temperature Measuring Point in the case of Forced Air Cooling

8.6 SUT6 Derating Curve

■ If you derate the output current, you can use the unit in the temperature range from -40°C to the maximum temperature shown below.

(1) In the case of Convection Cooling



Output Voltage(V) Input Voltage(V)	3.3	5	12	15	±12	±15
5	B	B	B	B	B	B
12	B	B	B	B	B	B
24	B	B	B	B	B	B
48	B	B	A	A	A	A

Fig.8.20 Derating Curve for Convection Cooling (SUT6)

(2) In the case of Forced Air Cooling (1m/s)

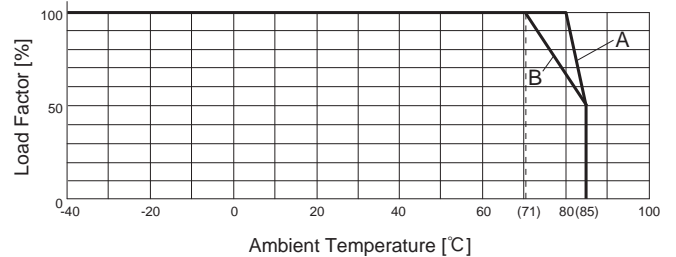

Output Voltage(V) Input Voltage(V)	3.3	5	12	15	±12	±15
5	B	B	B	B	B	B
12	B	B	A	A	A	A
24	B	B	A	A	A	A
48	B	B	A	A	A	A

Fig.8.21 Derating Curve for Forced Air Cooling (1m/s) (SUT6)

(3) Temperature Measuring Points in the case of Forced Air Cooling (1m/s)

■ In the case of forced air cooling, please have sufficient ventilation to keep the temperature of point A in Fig.8.22 at 95°C or below. Please also make sure that the ambient temperature does not exceed 85°C.

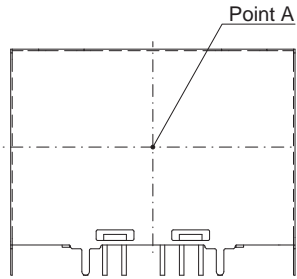
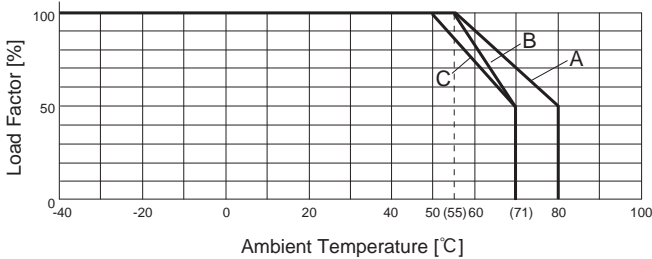

Fig.8.22 Temperature Measuring Point in the case of Forced Air Cooling

8.7 SUT10 Derating Curve

■ If you derate the output current, you can use the unit in the temperature range from -40°C to the maximum temperature shown below.

(1) In the case of Convection Cooling



Output Voltage(V) Input Voltage(V)	3.3	5	12	15	±12	±15
5	C	C	A	A	C	C
12	B	A	A	A	B	A
24	C	C	C	C	C	B
48	C	C	C	C	C	C

Fig.8.23 Derating Curve for Convection Cooling (SUT10)

(2) In the case of Forced Air Cooling (1m/s)

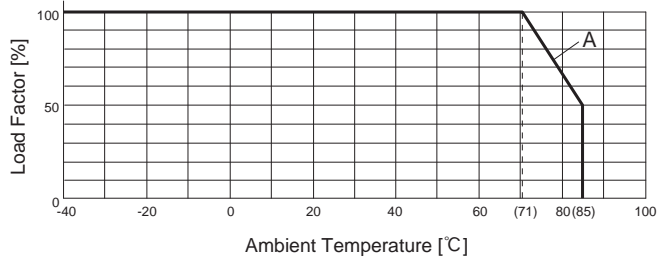

Output Voltage(V) Input Voltage(V)	3.3	5	12	15	±12	±15
5	A	A	A	A	A	A
12	A	A	A	A	A	A
24	A	A	A	A	A	A
48	A	A	A	A	A	A

Fig.8.24 Derating Curve for Forced Air Cooling (1m/s) (SUT10)

(3) Temperature Measuring Points in the case of Forced Air Cooling (1m/s)

■ In the case of forced air cooling, please have sufficient ventilation to keep the temperature of point A in Fig.8.25 at 95°C or below. Please also make sure that the ambient temperature does not exceed 85°C.

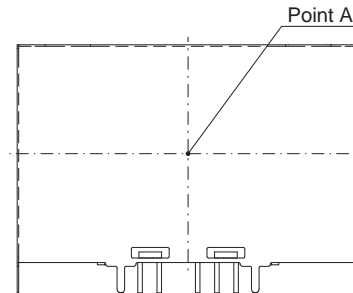
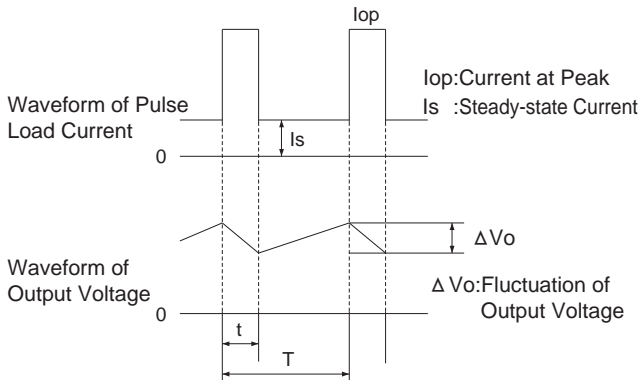
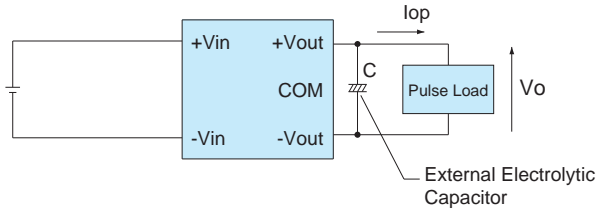

Fig.8.25 Temperature Measuring Point in the case of Forced Air Cooling

9 Peak Current (Pulse Load)

■ If a load connected to a converter is a pulse load, you can provide a pulse current by connecting an electrolytic capacitor externally to the output side.



■ The average output current I_{av} is expressed in the following formula.

$$I_{av} = I_s + \frac{(I_{op} - I_s) \times t}{T}$$

■ Required electrolytic capacitor C can be obtained from the following formula.

$$C = \frac{(I_{op} - I_{av}) \times t}{\Delta V_o}$$

10 Using DC-DC Converters

■ To Operate a Linear IC from 5V Output Power Supply

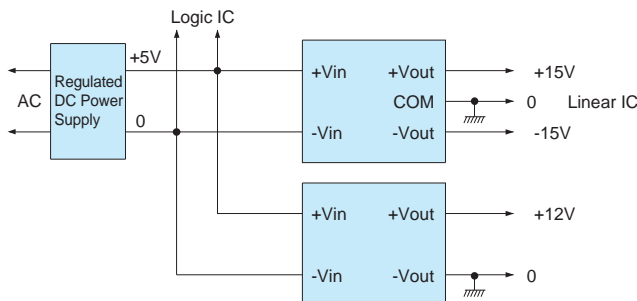

■ When Using a Non-regulated Power Source

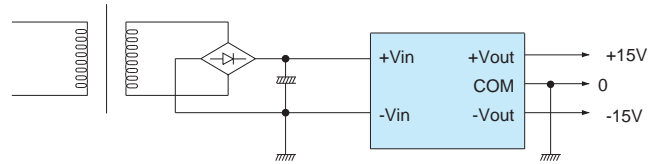

■ When Using a Battery-operated Device

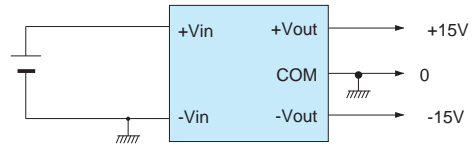

■ When a Floating Mechanism is Required for the Output Circuit

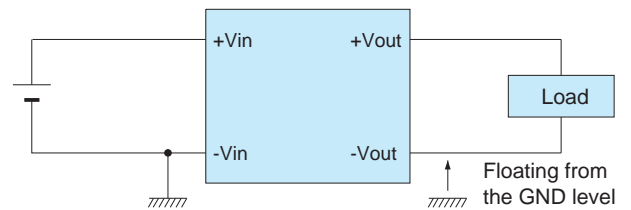

■ To Draw a Reverse Polarity Output

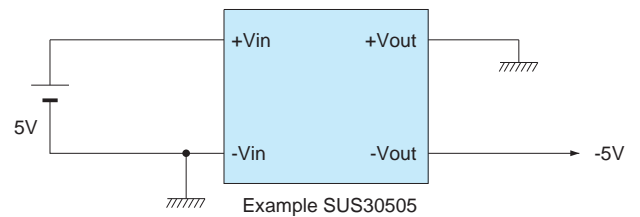

■ To provide a negative voltage to -Vin by using +Vin side of the converter as GND potential (0V)

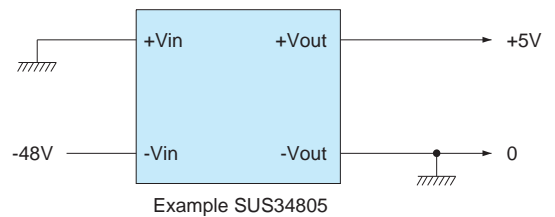

■ To Draw the Sum of Input Voltage and Plus Output Voltage

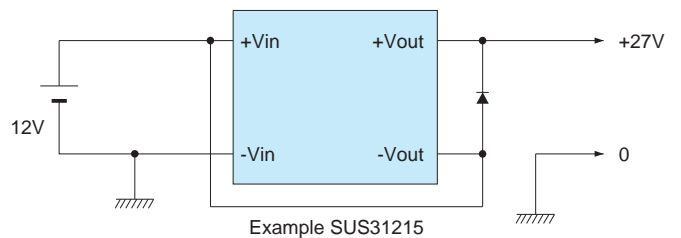

* Output current should be the same as the rated output current of the converter.

* Output current fluctuation is the sum of the input voltage fluctuation and the output voltage fluctuation of the converter.

■ To Use a Dual Output Type

*Dual output type is typically used in the following manner.

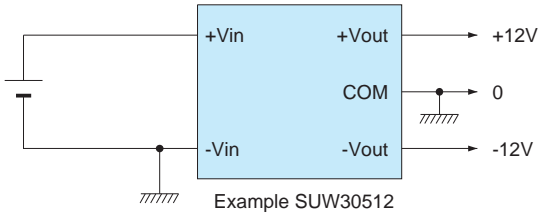

*The unit can be used as a 24V type single output power supply as follows.

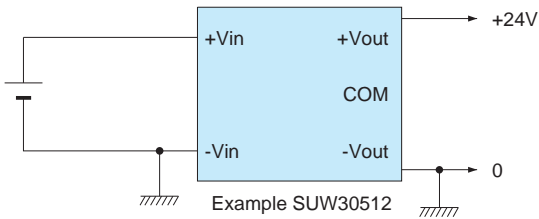

*Another way to use the unit is described below.

*The sum of +12V and +24V flows to the 0V line. Please make sure that this value does not exceed the rated output current of the converter.

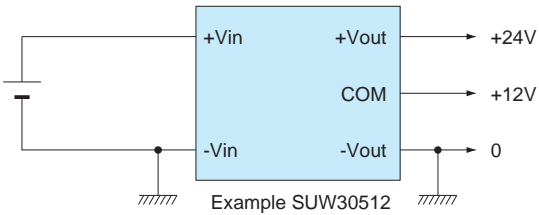

■ To Draw 48V Output

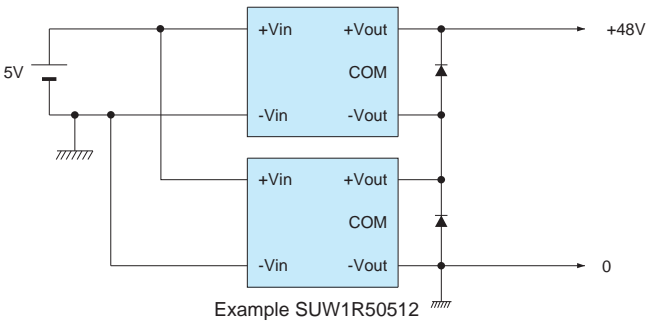

11 Options

11.1 Outline of Options

*Please inquire us for details of specifications and delivery timing.

● -C (Only SUC□□C)

- Conformal coating is applied to PCB and parts.
For excessive harsh environment with corrosive gases condition such as H₂S.
- Differences from standard versions are summarized in Table 11.1.

Table 11.1 Coating Type

Clearance to user board	0.05mm min (Refer to Fig.11.1)
Safety Standards	no approvals

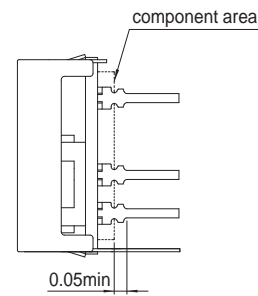

Fig.11.1 Clearance to user board

12 Delivery Package Information

■ These are packed in a tray. (Fig.12.1)

Please order "SU□□□□BP" for tray type packaging.

Table 12.1 Capacity of the tray (pcs/tray)

SU1R5	30max
SU3	30max
SU6	20max
SU10	20max

In case of fractions, the units are stored in numerical order.

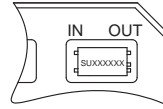

SU□□1R5□□□□BP

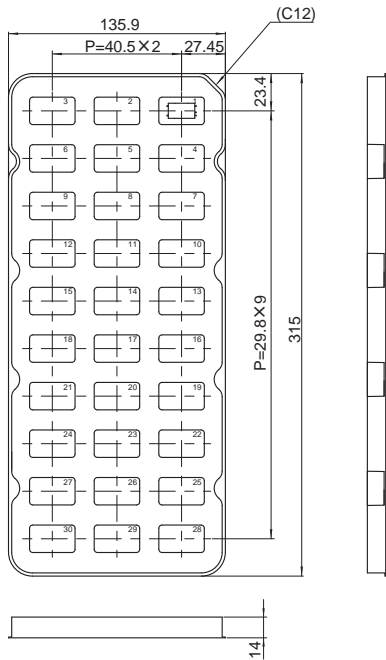

SU□□6□□□□BP

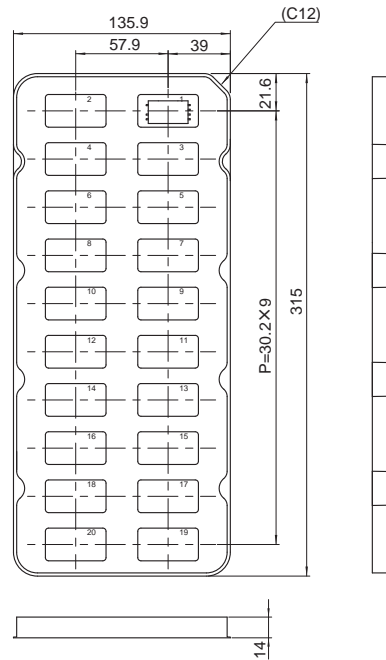

SU□□3□□□□BP

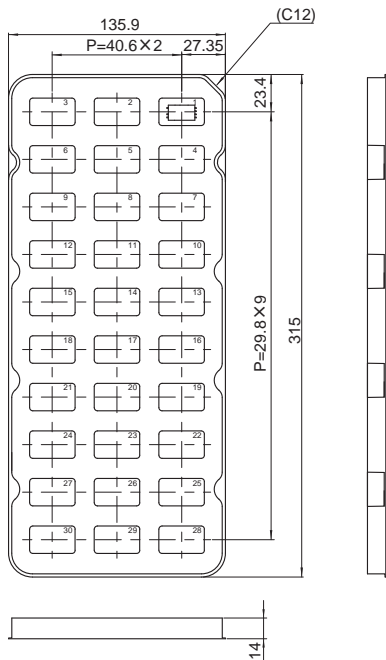

SU□□10□□□□BP

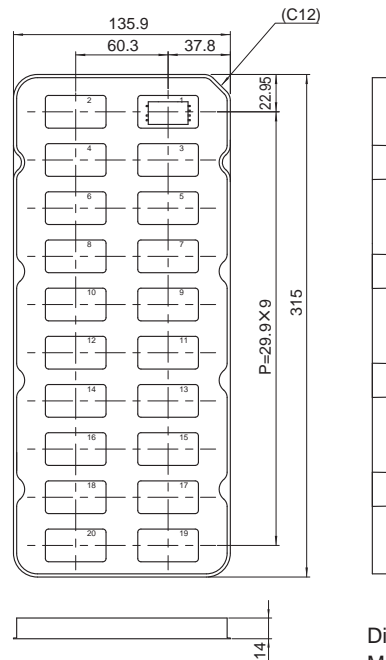

Fig.12.1 Delivery package information

Dimension in mm
Material : Conductive PS