



SWITCH FUNCTION	
POS. 1	POS. 2
	
OFF	(ON)
OPEN	1-2

(ON) = MOMENTARY



- NOTE:
- ALL DIMENSIONS IN MM [INCH]
 - GENERAL TOLERANCE: X.X±0.4
X.XX±0.25
 - TERMINAL NUMBERS FOR REF ONLY
 - CONTACT MATERIAL: SILVER
 - RATING: 2A 48VDC
 - TRAVEL: 1.5 ± 0.2mm
 - ELECTRIC LIFE: 200,000 MAKE-AND-BREAK CYCLES
 - INSULATION RESISTANCE: 1,000 MΩ MIN.
 - DIELECTRIC STRENGTH: 2,000 VAC MIN. FOR 1 MINUTE
 - CONTACT RESISTANCE: 50mΩ MAX. @ 1A 12VDC
 - OPERATING TEMP.: -20°C to 55°C
 - ▲ DENOTES CRITICAL PARAMETER.
 - INGRESS PROTECTION: IP65
 - HARDWARE SUPPLIED: O-RING AND HEXNUT
 - 2002/95/EC (ROHS) COMPLIANT

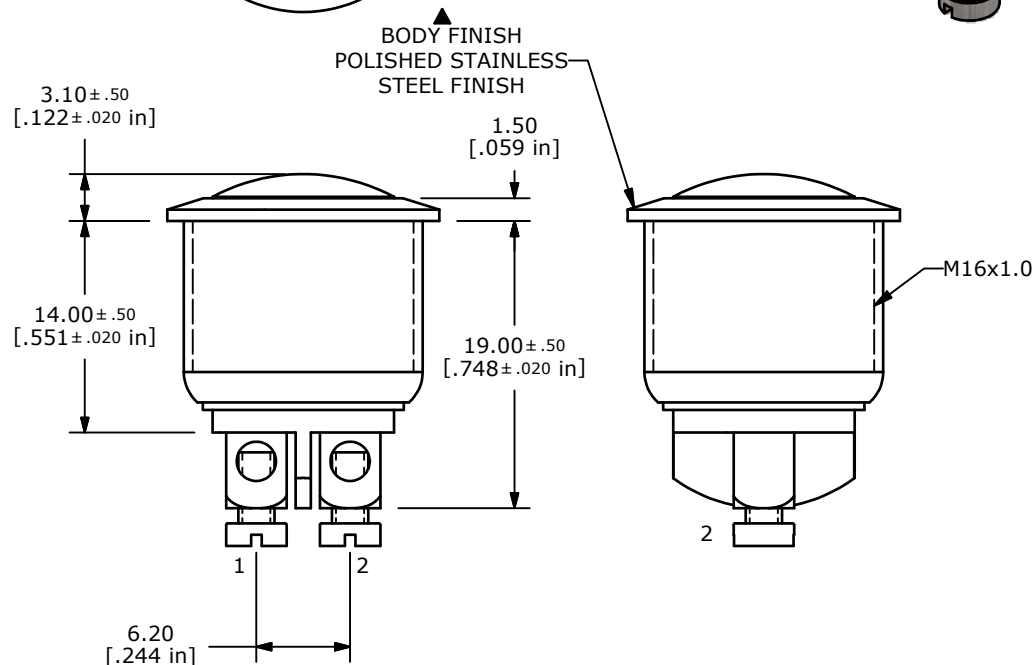
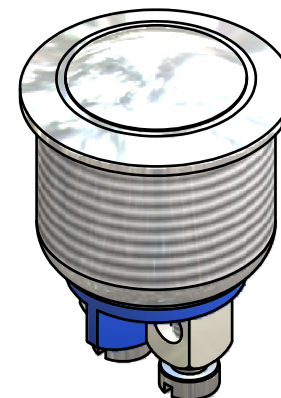
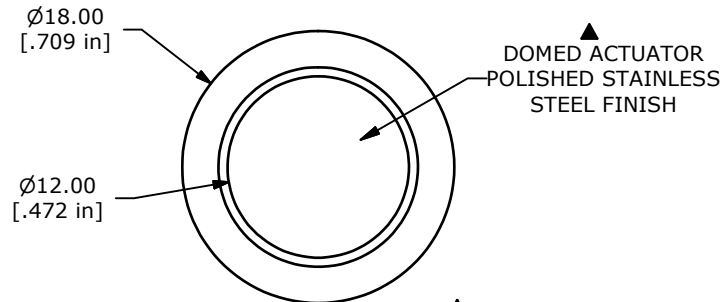
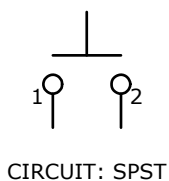
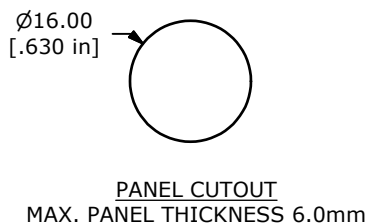

C	20390	REVISED AND REDRAWN	1/9/12	BGL
REV	PCR NO	DESCRIPTION	DATE	BY

TITLE PV2S640SS				
SCALE	DATE	DR	DWG	REV
2:1	1/9/2012	BGL	52-PV2S640SS	C

THE INFORMATION CONTAINED IN THIS DOCUMENT IS PROPRIETARY TO E-SWITCH AND IS NOT TO BE COPIED OR TRANSFERRED