

- NOTES:
1. ALL DIMENSIONS IN MM [INCH]
 2. GENERAL TOLERANCE: X.X=±0.4
X.XX=±0.25
 3. CONTACT RATING: 50mA @ 12VDC
 4. CONTACT RESISTANCE: 100 mΩ MAX.
 5. INSULATION RESISTANCE: 100MΩ MIN @ 500VDC.
 - ▲ 6. OPERATING FORCE: 100 ± 50gf
 7. TRAVEL: 0.2 ± 0.1mm
 8. OPERATING TEMPERATURE: -25°C TO + 70°C
 9. OPERATING LIFE: 200,000 CYCLES
 - ▲ 10. LED: GREEN
 11. ▲ DENOTES CRITICAL PARAMETERS
 12. 2002/95/EC (ROHS) COMPLIANT
 13. PARTS TO BE PACKAGED IN TAPE & REEL, 450 PIECES PER REEL

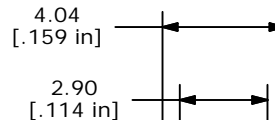

▲ COLOR MARK ON CATHODE LEAD

▲ CATHODE SIDE

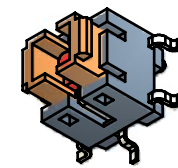
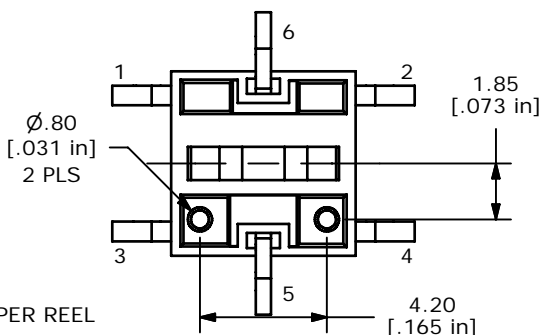
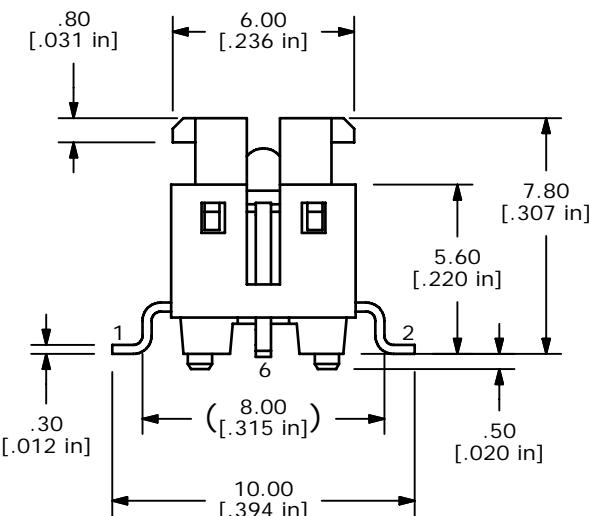
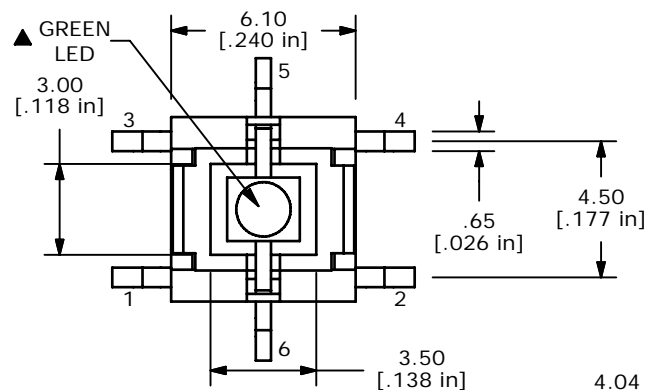
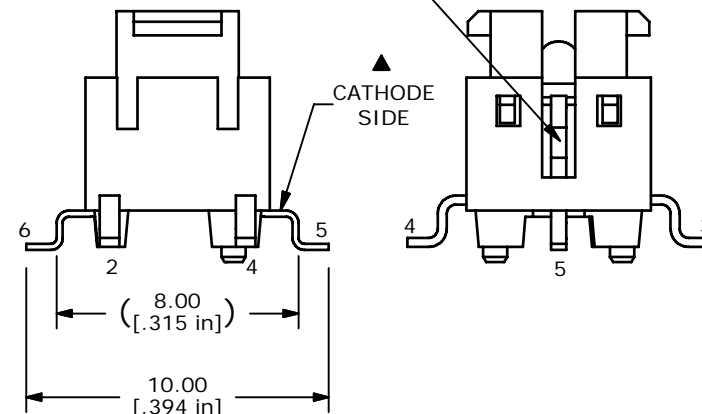

▲ LED SPECS	UNITS	VALUE
FORWARD CURRENT	mA	20
FORWARD VOLTAGE @20mA	V	2.0 TYP; 2.5 MAX
LUMINOUS INTENSITY @ 20mA	mcd	525 TYP



B	20570	Chg T&R qty from 500 to 450	4/25/12	rc
A	20373	New Release	12/12/11	rc
REV	PCR NO	DESCRIPTION	DATE	BY

TITLE TL3240F100G				
SCALE	DATE	DR	DWG	REV
4	12/12/2011	rc	N324004	B

THE INFORMATION CONTAINED IN THIS DOCUMENT IS PROPRIETARY TO E-SWITCH AND IS NOT TO BE COPIED OR TRANSFERRED